











## Self-contained ice maker - Sprayer system Daily production up to 25 kg

Hotel	████████████████████
Restaurant	██████████████████
Fast food	██████████████
Bar	██████████████████
Disco	██████████████████
Fish market	██████████████
Supermarket	██████████████
Medical & SPA	██████████████
Industry	██████████████

### ► Position n°



### ► Features & Plus

- Compact and crystal cube
- AISI 304 SS Scotch Brite finish 
- Possible ABS finish
- Tropical class +43°C 
- Cleanable antiscala filter 
- Air or water cooling system
- Easy cleanable internal rounded surfaces 
- HCFC-Free insulated storage 
- RoHS Free 
- Disappearing insulated door 
- Electromechanical operation 
- ON-OFF rocker switch 
- Standard and special voltages
- Patented sprayer slide



Possible ABS finish



Cleanable antiscala filter



Disappearing insulated door



Patented sprayer slide

### ► Available ice cube size



### ► Prod. 24h

°C	Air temp.		Water temp.		kg	lbs
	10° C	50° F	7° C	45° F		
	21° C	70° F	15° C	60° F		
					25	55
					22	49

**2 Years Warranty**  
subject to limitations

### ► Certifications available for this model





Ice Cube

**CB 184**

**Self-contained ice maker - Sprayer system**  
Daily production up to 25 kg

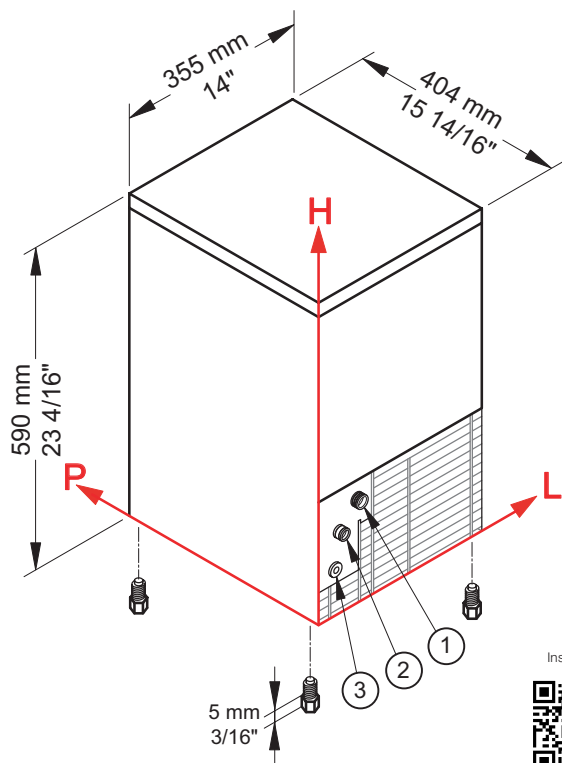
**► Working conditions**

- Location: **Indoor**

	Min	Max
Ambient temperature	+10° C / +50° F	+43° C / 110° F
Water temperature	+3° C / +37° F	+32° C / +90° F
Voltage	-10%	+10%
Water inlet pressure	1bar (14 psi)	6bar (84 psi)

**► Performances**

	Air temperature	Water temperature	Water temperature				
			7° C	45° F	15° C	60° F	21° C
	10° C	25 kg					
	50° F	55 lbs					
	21° C			22 kg			
	70° F			49 lbs			
	32° C					18 kg	
	90° F					40 lbs	

**► Connections**

All measures are referred to the rear bottom-left corner (L-H-Ø)

- ① Water in.: 88 mm / 3 7/16" - 184 mm / 7 4/16" - 3/4"      ② Water out.: 45 mm / 1 12/16" - 138 mm / 5 7/16" - 24 mm / 15/16"  
 ③ Electrical connections: 41 mm / 1 10/16" - 73 mm / 2 14/16"

**► Technical information**

Production in 24h	22 kg / 49 lbs	Water consumption	A: 4,5 l/kg - 53,9 gal/100 lbs
Store capacity, up to	4 kg / 9 lbs		W: 20 l/kg - 239,7 gal/100 lbs
Cooling system	A - W	Sizes (L-P-H mm)	355 - 404 - 590
Kind of cube	D-13g	(L-P-H in)	14 - 15 14/16 - 23 4/16
Refrigerant	R404A - R452A	Sizes with pack (L-P-H mm)	415 - 445 - 780
Standard voltage	220-240 V ~ 50 Hz	(L-P-H in)	16 5/16 - 17 8/16 - 30 11/16
Average power consumption	320 W	Net weight	27,5 kg / 61 lbs
Fuse	10 A	Gross weight	34 kg / 75 lbs
Finish	AISI 304 stainless steel, scotch brite - ABS blue or grey		

All the technical information need to be considered at the following conditions:

Standard Cube (13 g)  
 Ambient temperature +21° C  
 Water temperature +15° C  
 Average power consumption at +43° C (standard voltage)  
 Refrigerant R404A

Models and specifications are subject to change without notice

Rev. 03 - Issued May 2018



[www.bremaice.it](http://www.bremaice.it)  
[info@bremaice.it](mailto:info@bremaice.it)

Bim + Data  
 download

